

**GUARDIAN SERIES
MODEL - DISCOVERY 8'-0"**

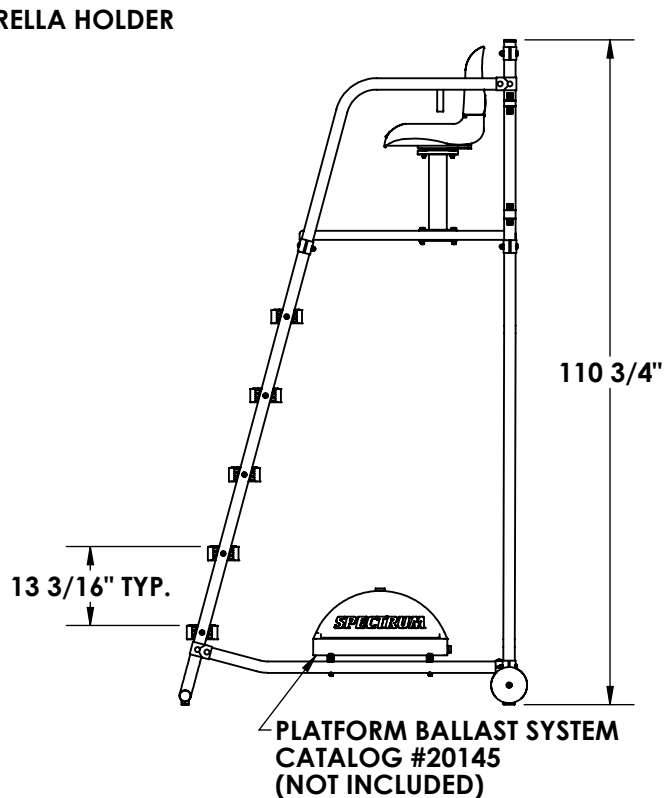
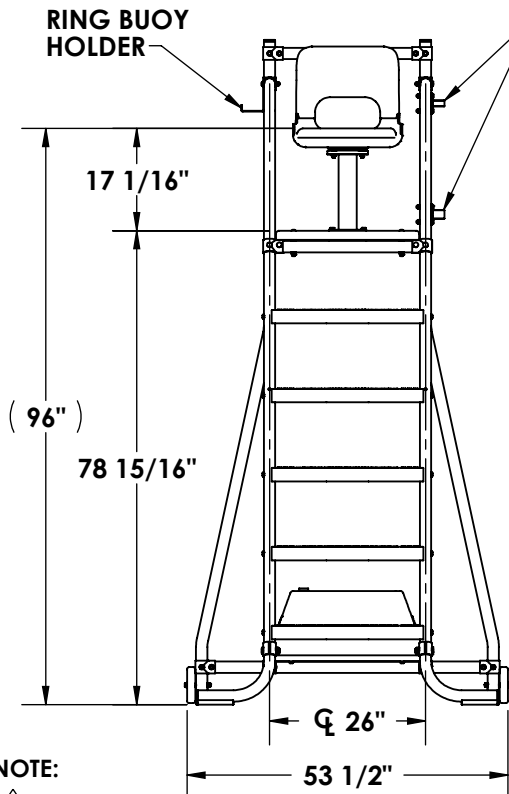
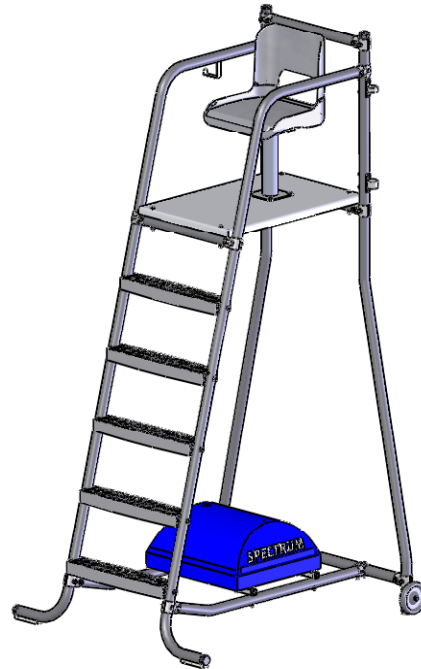
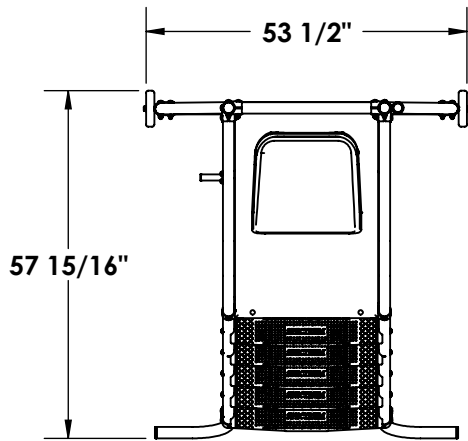

NOTE:

1 DIMENSIONS VARY WITH SPECIFIC APPLICATIONS.
SPECIFICATIONS ARE NOMINAL AND ARE SUBJECT TO CHANGE.
PLEASE CONTACT SPECTUM PRODUCTS FOR CUSTOM APPLICATIONS.

SPECTRUM
Products

7100 Spectrum Lane
Missoula, Montana 59808
406.542.9781 * 800.791.8056
Fax: 406.542.1158
www.spectrumproducts.com

ENGINEERING DATA

PRODUCT:	DISCOVERY 8'-0"
PRODUCT #:	20160
REVISION:	A
MATERIAL:	300 SERIES STAINLESS STEEL